

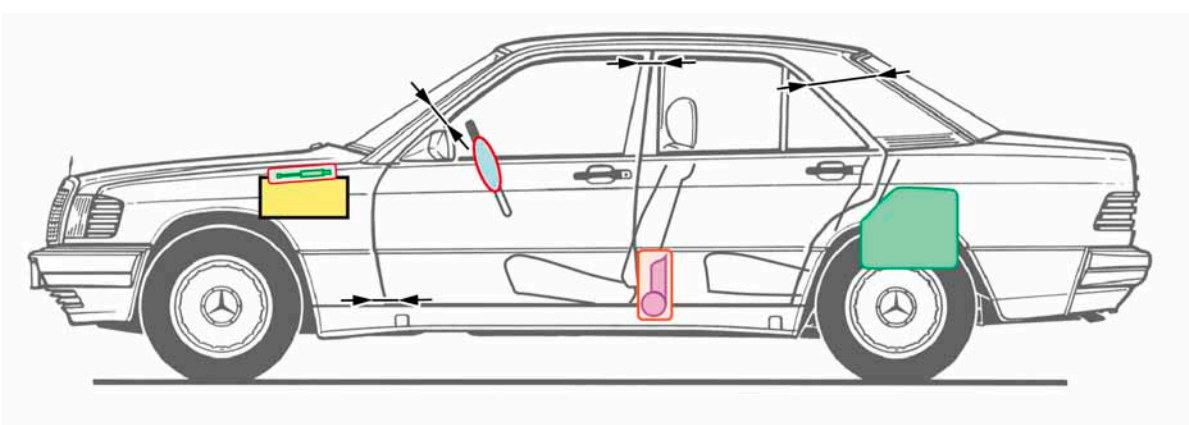

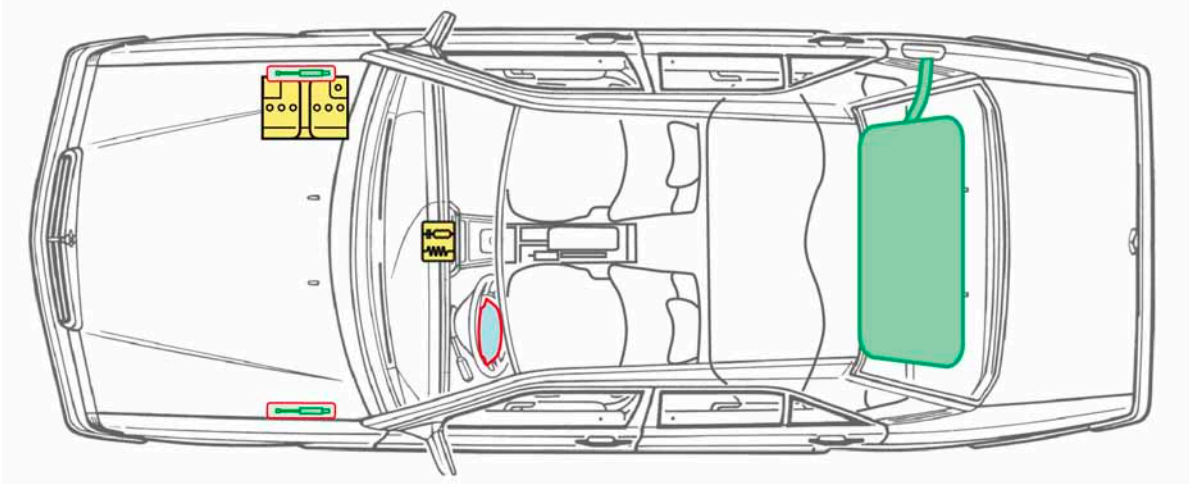





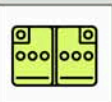
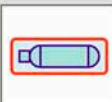

190  
Limousine  
Typ 201

1982-1993



Legende / Key / Пояснения

|   |   |   |  |  |  |
|---|---|---|--|--|--|
|  | Airbag<br>Airbag<br>надувная подушка безопасности                         |  | Karosserieverstärkung<br>Structural reinforcements<br>Усиление кузова            |  | Batterie<br>Battery<br>Аккумулятор   |
|  | Gasgenerator Gas generator<br>газогенератор                               |  | Überrollschutz<br>Active rollover protection<br>система защиты при опрокидывании |  | Hochvoltkomponenten<br>High-voltage components<br>компоненты высокого напряжения |
|  | Gurtstraffer<br>Seat-belt tensioner<br>натяжитель ремня безопасности      |  | Kraftstofftank<br>Fuel tank<br>топливный бак                                     |  | Schnittbereich<br>Cut here<br>резать здесь                                       |
|  | Gasdruckdämpfer<br>Gas filled spring device<br>Пневматический амортизатор |  | Steuergerät<br>Control unit<br>управляющее устройство                            |  |  |